

# **7x50 C**

**Instructions for use and maintenance**



## **Catalogue Index**

- 1. General Overview ..... (2)**
- 2. Technical Specification ..... (2)**
- 3. Construction Specifications ..... (3)**
- 4. How to use a Binocular with a military style reticle ..... (7)**
- 5. Binocular and accessories ..... (17)**
- 6. How to care for your binocular ..... (18)**

## **1. General Overview**

### **1.1 Main Character**

This model of 7x50 binoculars is made to military specifications including a range finding reticule. The optics are made to exacting military specifications in order to give the viewer excellent brightness, exacting image clarity and unparallel true color of the image whether it is a flower, bird where color is important or a military target. The user can have confidence whether it is being used in a military, public security, traffic control, boating, aviation, or any other application requiring confidence of equipment.

### **1.2 Model           7x50C**

### **1.3 Optimal environment:**

-43°C~+55T: (-40F-+131F)

## **2. Technical Specification**

### **2.1 Optical performance**

Magnification: 7x

Field of view: 7.5° (394 ft. @ 1000 yards/360M @ 1000 Meters)

Exit pupil diameter: 7.1 mm

Exit pupil distance: 21.8 mm (Long eye relief for eyeglass wears)

Diopter adjusting range: -5~+7 diopter

Interpupillary distance: 56-72 mm

Resolution: max 5.5''

## 2.2 Size and mass

Size (length x width x height) :

218mmx80mmX 157mm

Weight

Binoculars: max 1.4kg (3.08 lbs)

Complete product: max 2.2kgg (4.84 lbs)

## 3. Construction Specifications

### 3.1 Optical system

#### 3.1.1 Basic binocular construction

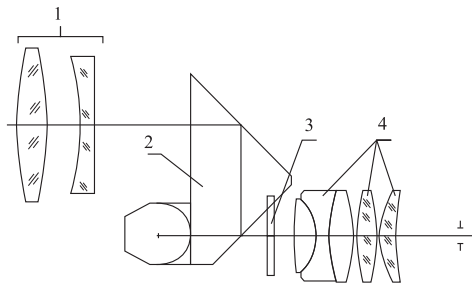

Fig. 1

Basic binocular optical construction, as shown in figure 1, consist of (1)the objective lens, (2) the erecting prisms, (3) the reticle and (4) the eye-piece. The reticle (3) is build in the right system.

### **3.1.2 How a Binocular works**

The light from the object or target you are looking at enters the binocular through the Objective lens system (item 1, fig. 1). Due to the objective lens, the image at this point is upside down. However, as the light rays of the image passes through the prism system, ( known as the erective prisms) ( item 2, fig. 1) it becomes right side up ( erect) and changed from right to left to left to right so written words appear correct. (Until this happen the word “word” looks like draw). At this point the image rays are now passed through the reticle lens (item 3, fig. 1). The image rays are now passed through the lens assembly (item 4, fig. 1) so that the observer can now see the distant object.

### **3.1.3 Reticule (See Fig. 3)**

There are vertical and horizontal lines on the reticule 3. Each small division on both vertical and horizontal lines represents 5 mils and each big division represents 10 mils (one circularity angle =6400 mils. (One circular angle equals 1 degree of angle, equals 1 minute of angle, equals 60 seconds of angle, equals 6400 mils.)

### 3.2 Body assembly ( Fig. 2)

Figure 2, illustrates the basic design and structure of a porro prism binocular like the 7x50. The binocular consists of identical two halves. A right side and a left side.

Item 1 is the lens assembly including the special reticle housing. The range adjustment for the diopter settings is from -5 to +7. Each mark of the diopter dial on the eyepiece reflects one diopter adjustment. Item 2 is the main binocular body housing the porro prism assembly. Item 3 is the objective lens assembly where the light from the image enters the binocular. Item 4 contains the interpupillary disc indicating the settings that correspond to the distance between the observer's eyes. This distance ranges from 56 mm to 72 mm.

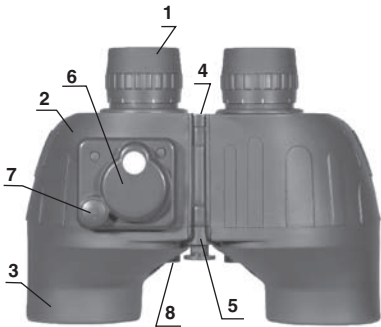

Fig. 2

Item 5 which is on the connecting shaft holding both halves of the binocular is where the objective lens caps are secure. Item 6 is the compass. Item 7 is the compass scale illuminator button. Item 8 is the battery cap.

## **4. How to use the binocular.**

### **4.1 How to focus the binocular.**

#### **4.1.1 Interpupillary adjustment.**

You must first adjust the binocular so that each eye piece is adjusted to the distance between your eyes. This is done by putting the binocular in both hands and adjusting the bino until you basically see one round image. Note: the image will not be clear. You will adjust for clarity in the next step. You must first fit the binocular to your eye width distance.

#### **4.1.2 Adjusting for the use of regular glasses or sunglasses**

This is a long eye relief binocular. It means that like other binoculars that do not have a long eye relief you can adjust the flexible rubber eyepiece. A long eye relief allows the eyeglass wearer to see a full image instead of a restricted one. If you are not wearing glasses leave the flexible eyepiece in the extended upright position. If you are wearing glasses then fold down the rubber eyepiece.

### **4.1.3 Adjusting for image quality and clarity.**

Unlike some binoculars that have a center focus to make adjustments this binocular has individual focusing adjustments. In order for you to adjust the optics to your individual eyes, you will need to adjust each eyepiece or ocular. After placing the binocular at your eyes, you will need to close your left eye. With your right eye open, you will need to take the fingers in your right hand and adjust the ocular until you see a perfectly clear image of the target you are looking at. Lower the binocular and remember the diopter setting for the right eye . Now closing your right eye, repeat the process you used for the right eye and turn the left diopter until you have a perfectly clear image. Again, take note of the diopter setting for the left eye. If, for some reason, the diopter settings are moved, such as letting some other person use the binocular, you will be able to quickly use (with out adjustments) the binocular again by setting the right and left oculars to their correct diopter settings for your eyes.

## **4.2 How to use the reticle measure azimuth**

### **4.2.1 What is azimuth**

The following is the basic definition of Azimuth. Azimuth of a body is the arc of the horizon intercepted between the north or south point and the foot of the vertical circle passing through

the body. It is reckoned in degrees from either the north or south point clockwise entirely around the horizon. Azimuth of a current is the direction toward which it is flowing, and is usually reckoned from the north point.

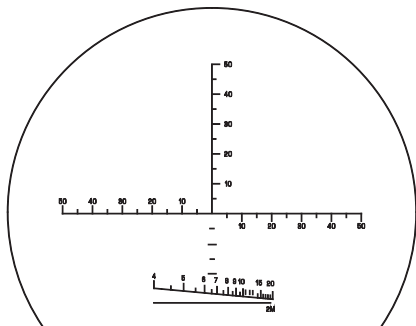

Fig. 3

A mil's reticule can measure the azimuth angle, upper and lower angle, distance and size of an object or target. The visual distance reticule lines can measure the distance of normal object easily on the basis that the object to be measured is at least 2 meters (6 feet) in height.

#### 4.2.2 How to measure the azimuth angle

The azimuth angle is the angle included between two objects to be measured at the hori-

zontal direction of the binocular. (Or two ends of one object at horizontal direction)

**4.2.2. A** When the azimuth of two targets is smaller than the azimuth measuring range (-50~+50 mils) inside the binoculars, aim the scale line at one end of the reticule at the target then read the value of the scale at which another target was located on the reticule. The value is the measured azimuth mil. As shown in fig. 4, the azimuth of the target (tank) is 0-20 mils. The azimuth between the targets (p-p) is 0-65 mils.

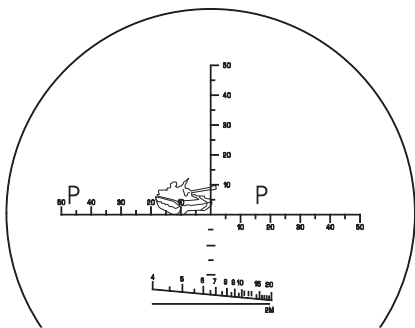

Fig. 4

**4.2.2. B** When the azimuth of two targets is bigger than azimuth measuring range (-50~+50 mils) inside the binoculars, on the target can be selected to make the necessary measurements in a step by step fashion. The sum of the

value from each step is used to obtain the measured azimuth. As shown in fig. 5, the azimuth of target (cruiser) is 130 mils ( $60+70=130$ ). When the azimuth of a target is longer than the azimuth measuring range ( $-50\sim1-50$  mils) inside the binoculars, you can visually calculate the total azimuth mils by using the vertical line on the reticle by placing the image in a position where the vertical line splits the image. You will need to take two image readings. Mentally, consider the horizontal with three reference points. Point A is the 50 mil point on the far left side. Point B is where the vertical line intersects the horizontal line. Point C is the far right 50 mil point. Now your first reading on the image will be the mils from point A to B with point A on the far left part of the image (see Fig. 5). Your second reading will be from point C to point B where point B is now the spot on the

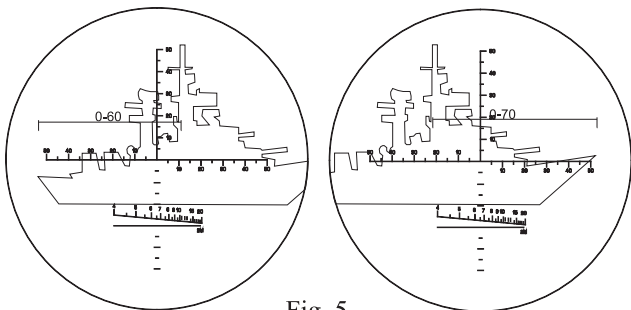

Fig. 5

image where point B ended after the first reading. After calculating the mils for each image, You then can add them together to get the total azimuth read-ing. In the (Fig. 5) image below the ship is longer than the total 100 mils available on the reticle. However, by doing the foregoing mil calculations, you can now obtain the ship's total mil azimuth of 130 mils (60 + 70 ).

### 4.2.3 Upper and lower angel measurement

Upper and lower angel means the angel included between any two targets (or two ends of a target) against the vertical line on the reticle.

4.2.3.A Upper and lower angel measurement is similar to measuring the azimuth. When the upper and lower angel measurement is very small, aim the cross center of reticle at lower part of the

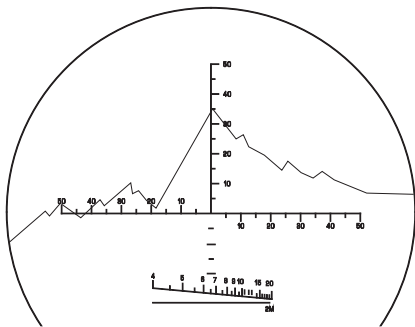

Fig. 6

target, read the scale value at the top of the target. The value is the measured mils of angle included between the upper and lower parts. As shown in fig. 6, the value of the lower part is 40, the angle included between the upper and lower parts of the target is 0-75 (75mils).

**4.2.3.B** When the target's upper and lower parts of the is than the mils on the reticle, it can be measured in steps and the angle can be obtained by summing up the value of each step. (The process will be similar to the one that is discussed in the linear measurements in 4.2.2 B above).

#### **4.2.4 How to use the reticle to measure distance**

**4.2.4.A** The distance measurement of a target can be calculated by using the mil reticle.

The formula of distance measurement:

$$D(KM) \approx h(M)/K \quad D(KM) = H(M)/K$$

D - the distance between the observer and the target (km)

H - the height of the target (m)

K - upper and lower angle of azimuth of the target measured with the reticle of binoculars (mil).

When measuring the distance, first, estimate the height or width of the target, then measuring upper and lower angle of the target. Accord-

ing, you can calculate the distance between the observer and the target using the formula. For example:

There is an adult whose height is 1.70m.  
( $H=1.70\text{m}$ )

The upper and lower angle of the adult is 0 - 40  
mils ( $K=0 - (-40)$ )

$$L=H/K=1.7/40=0.0425\text{km}=42.5\text{m}$$

Therefore: the distance between the observer and the adult is 42.5m.

**4.2.4.B** How to measure distance directly using the reticle in (Fig. 7)

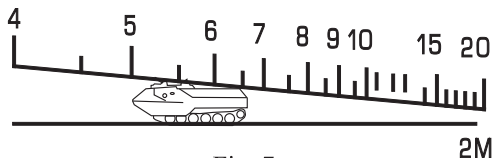

Fig. 7

For example, if the target is 2 meters in height, place the lower part of the target at the horizontal line on the reticle with the upper top part of the target against the angled scale line. The reading on the top of the target. Where the top of the target or image touches the top of the angled scale line is the distance between the target and the observer, (line value : 100m) as shown in fig 7,

the distance between the target and the observer is 550m.

#### **4.2.5 How to measure a target's size (height and width) using azimuth readings**

According to the formula for distance measurement, you can calculate the height using:

$$H = D \times K.$$

When measuring the size, you first estimate the distance to the target, then measure the azimuth or upper and lower angle. With these measurements, you can calculate the height of the target using the formula. For example: the distance is 0.6km between the observer and the target. You can measure that the azimuth is 60 (0-60) and the upper and lower angle is 30 (0-30). So, using the formula you can get:

The height:  $H=0.6 \times 30= 18\text{m}$

The width:  $h=0.6 \times 60=36\text{m}$

#### **4.3 How eyeglass users can use long Eye relief feature**

If you wear prescription glasses or regular sun glasses, you can still obtain a full image view by turning down the rubber eyecups on each of the eyepieces or oculars. All binoculars feature fold down eyecups, but only binoculars, like this model, featuring a long eye relief optical system

offers the using a true full feature viewing while wearing glasses.

#### **4.4 How to use the compass**

The compass is a precision unit. It has extremely fast dumping so that there is almost no “swing” and is connected for dip (Latitude). The compass scale is in one degree increments and is aligned with the vertical range finding scale. When using the compass, always keep in mind the local variation between magnetic and true north. Binocular compass uses degree measurements. North =  $360^\circ$ , East =  $90^\circ$ , South =  $180^\circ$ , West =  $270^\circ$ .

The compass model comes with built-in LED compass illuminator for us at night and low light conditions. When the ambient light does not permit you to see the compass heading clearly, press the button atop the right tube. If the light is dim or does not come on, replace the batteries. If



the light does not operate after replacing the batteries, please contact the dealer nearest you.

#### **4.5 How to change the batteries**

To change the battery, use a thin coin to remove the battery cap by turning it counter-clockwise. Remove the two batteries. The batteries have a (+) on the front and a (-) on the back. Be sure to insert the new batteries with (+) signs in the same direction. Replace the battery cap by turning it clockwise.



### **5. Binocular and accessories**

7x binocular	1 pc
Carrying strip	1 pc
Eyepiece cap	1 pc
Brush	1 pc
Lens cleaning cloth	1 pc
Instructions	1 pc
Soft case with carrying strap	1 pc

## **6. Storage and maintenance**

Binoculars are precision optical instrument. It should be carefully handled and maintained in order to keep it in good working order.

### **6.1 General Maintenance**

6.1.1 Lenses: Always clean the lenses after each use and before you put it back in it's carrying case. After each use, brush any dust or dirt of the lenses with the special optical brush that came with your binocular. After brushing, gently wipe each of the lenses with the special optical cloth. Never use your finger to wipe the lenses as body oil will get on the lenses possibly damaging them. Never use anything to wipe your lenses except special optical cloths. Always keep your optical cloth in the binocular case for easy access for cleaning.

6.1.2 Although the eyepieces are made to turn for individual eye diopter adjustments, do not turn them beyond the factory set stop. Forcing it beyond this point will damage the eyepiece optics and make the binocular unworkable.

6.1.3 After using, always remember turn the diopter adjustment to its infinity position to avoid any damage of the ocular system in case of accident.

6.1.4 Avoid any extreme shaking or dropping of the binocular. This may damage the internal optics and prisms. Store the binocular in a dry and well ventilated place.

## **6.2 Maintenance**

If you find that the binocular not working correctly, do not try to repair it yourself. Trying to repair it yourself may void any warranty you have on the binocular. Always, take or send it to a professional binocular repair station. If one is not readily available, then send it back to the factory.

